

*the***ultimate**[®]
collection



Modern Design ♦ High Security ♦ Energy Efficient
PVC-u Windows & Doors



Welcome

This guide has been designed to help you fully understand the numerous benefits included with the Ultimate Collection of windows and doors.

The success of the Ultimate brand is largely down to the many features that will not only enhance the appearance of your home, but also the security and energy efficiency.

The homes that inspire us are the ones that reflect our personalities. We all have different lifestyles, favourite colours and tastes.

So we would like to show you that choosing windows and doors can be inspiring and that it is possible to design something that is not just functional but becomes as unique to you as your home is.

Contents

Frame Style and Finish	Pg 4
Window Energy Ratings	Pg 8
Maximise the Opening	Pg 10
Window Security	Pg 12
Window Handle Options	Pg 13
Trickle Ventilation	Pg 14
Ali-lock External Georgian Bar	Pg 15
Internal Georgian Bar	Pg 16
Versatility in Design	Pg 18
Ultimate Entrance Doors	Pg 20
Door Furniture	Pg 22
Double/French Doors	Pg 24
Bi-fold and Sliding Patio Doors	Pg 25
Quality Assurance	Pg 26



BEVELLED PROFILE

OVOLO PROFILE



An initial choice you will want to make is whether to have bevelled or ovolo shaped profile. Bevelled profile offers contemporary clean lines whilst ovolo profile offers a more detailed, sculptured finish.



This choice can often be influenced simply by your individual preference but may also be influenced by the style of your property.

Colour and finish options

Options now extend far beyond the traditional white window. The Ultimate Collection offers you so much choice in terms of style and finish that you should never need to compromise.

BEVELLED PROFILE FINISH OPTIONS



OVOLO PROFILE FINISH OPTIONS



BASE COLOURS

Rosewood, Cherrywood, Irish Oak = Dark Brown Base.
 Dark Grey 7016 both sides and Smooth Dark Grey 7016 both sides = Grey Base.
 All other = White Base.

Due to possible variations in the printing process, please refer to physical colour swatches for an accurate representation of these finish options.



If you would like a colour that is not within our range of woodgrain foils, we can arrange to have your windows or doors spray painted in the colour of your choice.

You can choose to have the colour applied to both the inside and outside faces, or outside only leaving a fresh white internal finish.



Ovolo profile windows in Rosewood finish



Ice Cream Woodgrain windows with Georgian Bar detail



Close up showing the available realistic black woodgrain effect



Grey working well with cream exterior render

Importance of the finish

With the rapid advancement in PVC-u technology, you would often now be hard pressed to tell the difference between PVC-u products and their timber equivalents.

This provides you with a multitude of finish options. You may find for example that choosing a Rosewood or Oak woodgrain finish will help to blend more sympathetically with your home and garden.

Colours such as Black, Grey, and Cream are also increasingly being used to great effect as well as an array of bespoke coloured woodgrain colours. And remember, unlike their timber equivalents, they will not need painting, and they will be guaranteed for years to come.



Rosewood Finish on Bevelled Profile

Window Energy Ratings



As part of the Governments overall initiative to reduce the levels of carbon dioxide emissions, they have put controls in place to reduce the energy lost from domestic dwellings.

Window heat loss can account for a substantial proportion of the total heat loss from your home. Therefore replacement windows are now energy rated which will help to reduce harmful CO2 emissions and help cut the cost of heating bills.

Ultimate window profiles along with the glass sealed unit specification are fed into a computerised simulation test to measure:-

Solar heat gain

Thermal losses

Air losses

Based on the results, windows are then rated from A-G with A-Rating being the most thermally efficient.

Solar heat gain (Positive)

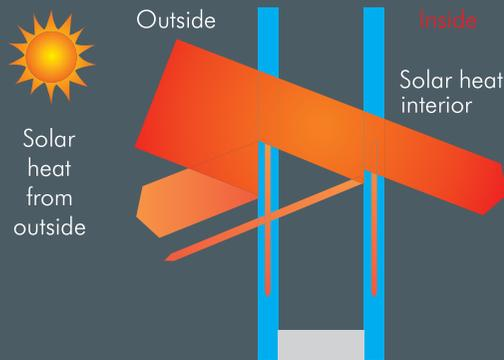

Solar heat is reflected, absorbed and transmitted

Thermal losses (Negative)

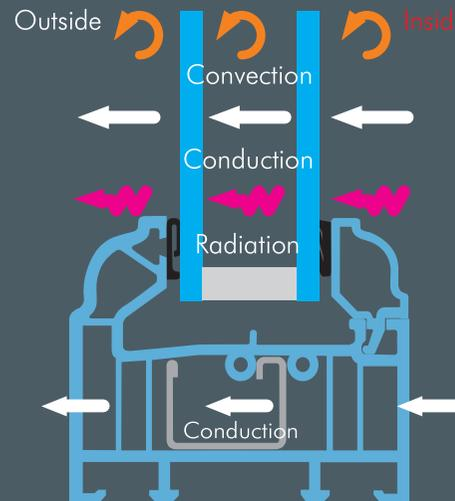

Thermal losses from convection, conduction and radiation

Air losses (Negative)

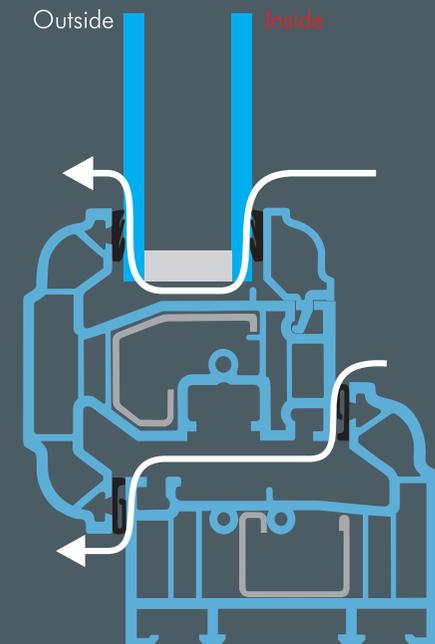

warm air leaks out through the window

Why choose Ultimate?

In order to meet the governments thermal performance targets and current Building Regulations, all replacement PVC-u windows are to achieve a U-value not exceeding 1.4 (W/m².K) or Window Energy Rating 'B' or better.

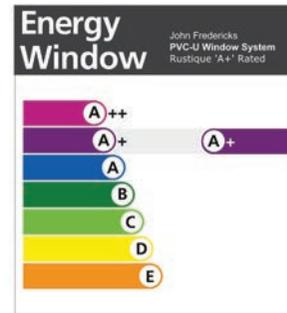
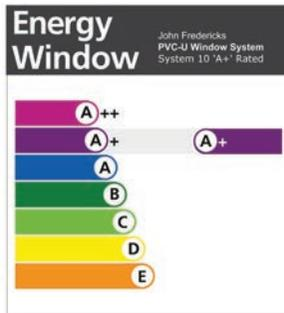

Reg. No.: 5092 MD47
Review Date: 12/2016
BFRC Please visit www.bfrc.org to check the validity of this licence.

Reg. No.: 5091 MD47
Review Date: 12/2016
BFRC Please visit www.bfrc.org to check the validity of this licence.

Ultimate Windows achieve an A+ Energy Rating with an Energy Index of 10 and a U-value of 1.4 (W/m².K).

High quality PVC-u material, technically superior profile system incorporating state of the art recycling technology

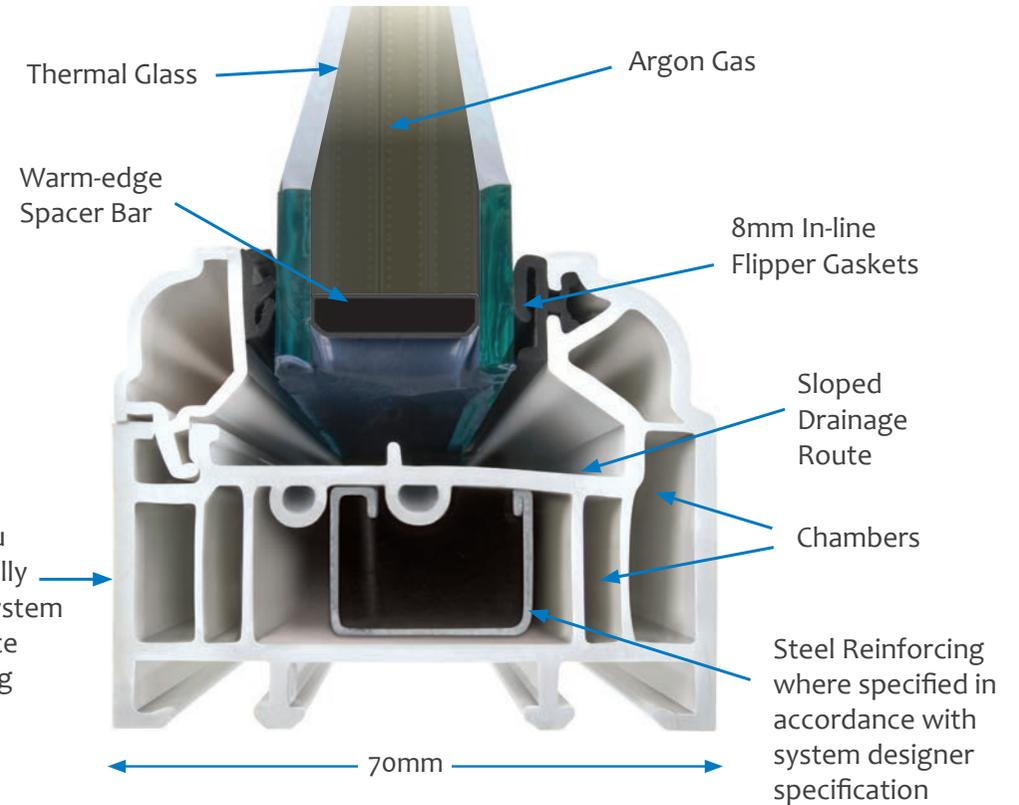

The red glow shown left, on the internal face of the entire window area symbolises the amount of heat Ultimate windows retain.

As a result, the inside of your property remains warmer and more energy efficient.

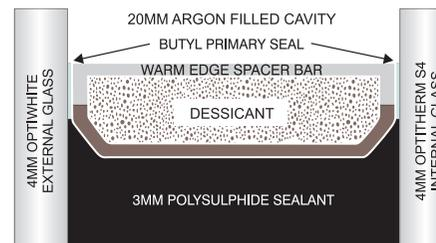

Typical A-Rated Sealed Unit

Reduce home heat loss and save money with Ultimate Energy Efficient Windows.



Maximise the opening

The owners of this property wanted to maximise the size of the opening of the kitchen window.

The solution was a cottage style window (French Casement) with a floating mullion.

The floating mullion is purposely designed to house the locking system so a central fixed vertical mullion is not needed between the two opening sashes.

When the windows are fully open, you get the maximum benefit and when the windows are closed, the floating mullion gives the appearance of a fixed frame between the two opening sashes.



The floating central mullion allows the windows to benefit from the maximum opening without the obstruction of a fixed vertical frame between the opening sashes



ultimate[®] security

The Ultimate window has been refined and designed to protect you and your home and provide you with total reassurance and peace of mind.

The locking technology at the heart of every casement window incorporates 10 security features (subject to casement size*).

A total of 10 security points, in all four directions

2 x steel shoot bolts

4 x central collared cams

2 x high security fire escape / easy clean hinges

2 x 15mm anti-jemmy hinge bolts



BS 7412/PAS 24
KM 36015

* Shoot bolt and night vent functionality are dependent on the dimensions of an opening sash. Therefore small sashes may not have one or both of these functions. Limited night vent locking available on French Casement windows; master sash only on rebated sash French Casements and none on flush sash French Casements.



Steel Shoot Bolts



Collared Cams



High Security Fire Escape / Easy Clean Hinges



15mm Anti-jemmy Hinge Bolts

handle options



White



Black



Graphite



Gold



Chrome



Satin



Bronze



Antique Black



Chrome
Teardrop Handle



Gold
Teardrop Handle



Graphite
Teardrop Handle



Antique Black
Teardrop Handle



Chrome
Monkey Tail Handle



Gold
Monkey Tail Handle



Graphite
Monkey Tail Handle



Antique Black
Monkey Tail Handle





Trickle Vents installed through the window sashes



Trickle Vents installed through the outer frame
Also showing the functionality of the internal link vent closure plates



Concealed Ventilation installed through the outer frame



Trickle Ventilation is a Building Regulation Requirement

As of 15th June 2022, Approved Document F of the Building Regulations that specifically relates to ventilation, requires that adequate ventilation is provided throughout a property.

Adequate ventilation will ensure that air flows through the property by allowing stale air and harmful pollutants to escape, helping to reduce the spread of airborne viruses such as Covid 19 whilst maintaining a good level of air quality, particularly important to allergy sufferers and those with Asthma.

Ventilation is also crucial in helping to prevent the accumulation of excess condensation which could have an adverse affect on the structure of your home and your health.

In the absence of a suitable mechanical ventilation system, conforming to these regulations requires the use of trickle vents fitted into windows.

Ultimate Collection Windows are able to meet these requirements with an efficient, safe and secure trickle vent for your home.

- Ventilators match to your chosen frame colour
- Hooded external canopy prevents water and insects from entering the home
- Helps to ventilate stale air, harmful pollutants and reduce condensation
- With the innovative 'Link' the closure plate can be positioned to reduce draughts with the benefit of directing air away from the occupants
- Ventilate your house, without having to open the window



Hooded external canopy



Innovative link vent with closure plates

Concealed Ventilation Canopy

You also have the option of concealed ventilation.

The ventilation is built into the head of the outer frame which is concealed by a full width aluminium exterior canopy, colour and finish matched to your window frames.

The same interior link vents with closure plates are used on the inside of the window.

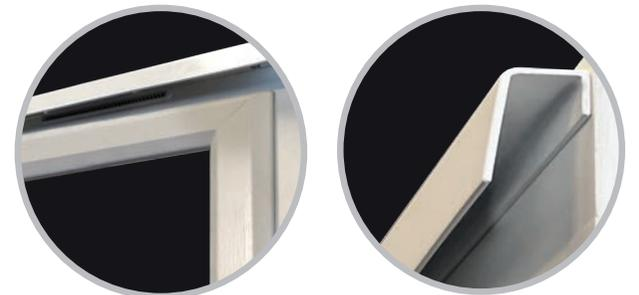



Ali-lock Authentic External Georgian Bar

You may decide to have decorative Georgian Bars applied to your windows for the truly authentic Georgian style.

The unique Ali-lock Georgian Bar is a scribed PVC-u bar, finished and colour matched to the exact same finish of your chosen windows.

The bars are connected to full length aluminium fixing strips that are bonded to the glass unit. This, combined with the spacer bar grid design inside the unit, gives the impression that each pane is a separate unit.



The innovative Ali-lock bar system ensures the Georgian grille does not shrink, warp or detach, regardless of weather conditions.







Internal Georgian Bar

In contrast to the Ali-lock External Georgian Bar system where the bar is applied onto the outer faces of the insulated glass unit, as the name suggests, Internal Georgian Bars are held within the sealed glass unit.

Internal Georgian Bars still provide an effective feature but with the bars inside the glass, the glass maintains a flat surface with no protrusions and are therefore easier to clean.



Versatility in Design

In order to cater for the diverse mix of property styles and consumer preferences, windows and doors are now available in a wide variety of styles and finishes.

Using a combination of top openers, side openers and fixed panes, the range of styles is immense so you are sure to find a design to suit your home.

Similarly, there is no reason to compromise when replacing bay windows. Not all bay windows are the same, some require load bearing support. The Ultimate Collection offers load bearing support components to suit both 90° bay windows and multifaceted bays. Using our versatile bay posts, a variety of combinations can be assembled to achieve the correct angles.

Smart Safety Solutions

For your safety, high security fire escape / easy clean hinges are fitted as standard to all side-opening windows. These will open fully to give you an alternative means of fire escape (dependent on window size) and can slide towards the centre to allow easy external cleaning.

'PRESS' the release clips located on the top and bottom hinges and simply slide the window across for easy external cleaning. The window will automatically realign upon closing.

The release clip is clearly marked with the word 'PRESS' as shown right.



Fire escape / easy clean functionality

Dummy casements provide Equal Sight Lines

The owners of this property have chosen to have opening sashes in the tops of the windows and fixed dummy casements in the lower half.

Viewed from the outside all appear to be opening windows and therefore help to maintain a neat, balanced symmetry throughout the property known as equal sight lines.



The below example clearly shows how dummy casements help to achieve equal sight lines. The left image shows opening sashes either side of a fixed pane.

The right image also only has opening sashes either side but a dummy casement has been added in the centre to provide equal sight lines and give the impression of three opening sashes.





3 section 175mm Midrail

Please be aware the 175mm Midrail is made from 3 sections and features 2 horizontal lines where the 3 sections are joined.

Ultimate Entrance Doors

Choosing the right entrance door for your home is an important decision as your front door creates the first impression and the all important kerb appeal.

Your choice of door and glazing design can help define the overall style of your home and add light to an otherwise darkened hallway.

Allow yourself time to decide what is right for your home, whether it be traditional or contemporary you are sure to find a style that suits.

Ultimate doors give you almost endless style and colour choices, so now your door can really reflect your personality. With the vast choice of finish options and an elegant range of door furniture, it's now possible to emulate most timber door styles in PVC-u.

And don't forget, if you would like a door colour that is not within our standard range of colour options, we can arrange to have your chosen door design spray painted in the colour of your choice with the colour applied to both the inside and outside faces, or outside only leaving a fresh white internal finish.



175mm



195mm

Optional Deep Timber Look Midrail

As an alternative to the standard Slimline Midrail, Ultimate Bespoke doors give you the additional options of the 3 section 175mm Midrail or 1 section Deep Timber Look 195mm Midrail*.

*Options may be determined by frame and colour choice.



Optional Deep Timber Look Cill

The timber style features can be carried right through to the cill with the option of a timber look PVC-u cill, deeper in proportions to a standard PVC-u cill (also available with Ultimate Collection Windows)

Door Security

For your security, Ultimate Doors are fitted with a robust **12/14 point multi-lock**.

Ultimate 12/14 Point Lock

2 x top and bottom shoot bolts.

3 x outer/inner facing hook locks.

2 x dead locks.

1 x centre locking latch.

4/6 x roller cams
(dependent on door height).

Plus 2 x Optional
Anti-jemmy Hinge Bolts



Shoot Bolts



Hook & Dead Locks



Compression
Rollers Cams



Anti-jemmy Hinge
Bolts (Optional)



Hinges (other
finishes available)

To prevent cylinder manipulation, Ultimate doors are fitted with a 3 star high security Yale cylinder, and for convenience all doors are supplied with 5 keys as standard.



**theultimate[®]
collection**

Partnership secured with **Yale**



Townhouse Lock Option

As an alternative to the standard locking system, you may wish to consider our townhouse lock option.

The townhouse lock is completed with a traditional escutcheon finger pull.

This option also includes the high security cylinder as detailed above.



1 section 195mm Midrail

The below installation utilises the optional 1 section 195mm midrail. Here the midrail runs through both the door and side panels for a balanced appearance.



DOOR FURNITURE

Door Handle Options



Letter Box Options

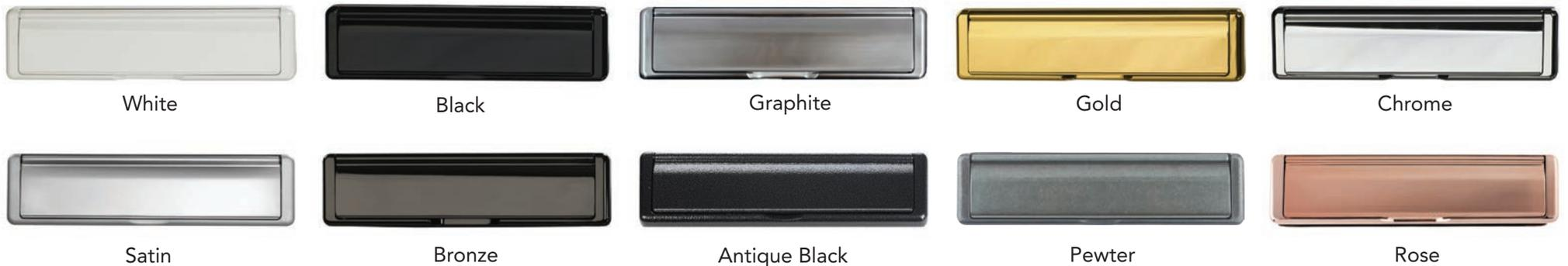

ADDITIONAL FURNITURE OPTIONS

Bull Ring Knockers

Great design is all about the detail.

Our specialist range of Bull Ring Knockers will provide the finishing touches and all important kerb appeal.

This functional yet aesthetically pleasing knocker is available in the following finishes.

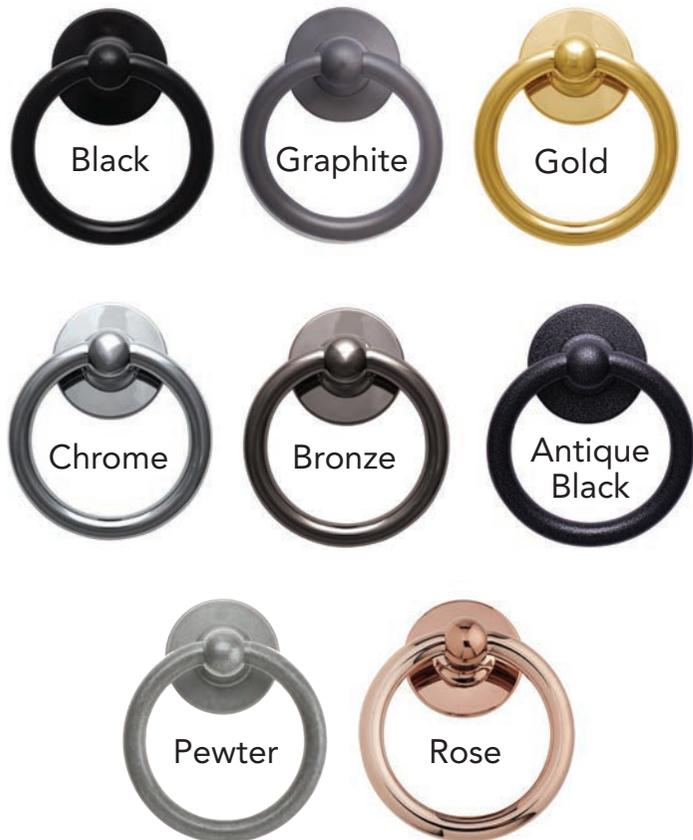

Decorative Door Knobs

This elegant range is available in the following finishes.

White
Black
Graphite
Gold
Chrome
Satin
Bronze
Pewter (shown)
Antique Black



Period Door Furniture

For period style doors, the below ornate furniture is available.

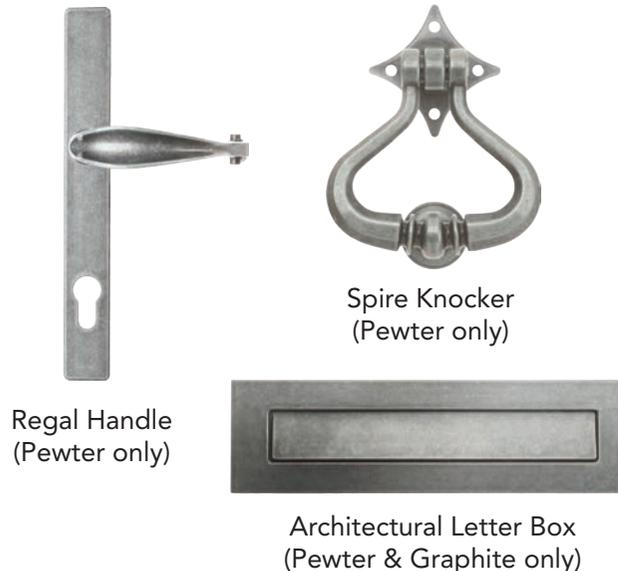

Grade 316 Austenitic Stainless Steel

For areas of the country, particularly susceptible to increased corrosion such as coastal areas, you have the option of our Grade 316 Austenitic Stainless Steel suite of door furniture. The suite comprises of a handle, door knocker and letter box as featured below.



Contemporary door styles can be enhanced further with the addition of Grade 316 Austenitic Stainless Steel offset pull bar handles.

You have a choice of 3 bar lengths, 1800mm, 800mm and 400mm.





French/Double Doors

French Doors, often with full height glazing can provide additional light to a room. They are used both internally as a partition from one room to another or externally to provide elegant access to the garden.

These door styles will also provide a practical wider opening, particularly useful when moving larger items to and from the property. When the opening is too narrow for a Bi-fold or Patio Door, French Doors can often be the perfect solution.

All Ultimate French Doors include the same multi-point lock that is fitted to single doors with additional shoot-bolts fitted to the slave door.





Sliding Patio Doors

Modern day comfortable living comes in a variety of forms.

Where light and space is key, large glass surface areas such as Sliding Patio Doors will help to bring in more light and provide that contemporary spacious feel.

They are particularly suited to rooms restricted in size or space with the doors sliding horizontally and therefore not encroaching on internal space.

Security is covered with opposing hooks locks, internal/external locking, aluminium inter-lock section and anti-lift device.



Bi-fold Doors

Bi-fold doors are designed to provide the ultimate view. These stunning doors instantly create a contemporary look and feel.

With sleek profiles and sympathetically designed handles the doors simply concertina together so you are able to enjoy the maximum opening and invite the outside in.

Modern Bi-folds are designed to withstand the rigours of the UK climate allowing you to sit back and enjoy your garden in comfort all year round.

Bi-folds are available in up to 7 door leaves, over 20 different opening configurations and a range of frame and furniture colour options.



ISO 9001:2015
FM 33147



BS 7412
KM 36014



BS 7412/PAS24
KM 36015

Ultimate products are put through regular stringent tests to ensure a consistent high level of quality, but don't just take our word for it...

The British Standards Kitemark is one of the most well known and respected product certification marks in the world and is your reassurance that BSI has checked that your Ultimate PVC-u windows and doors comply with the latest British Standard.

Quality Assurance ISO 9001:2015

This certification was awarded for providing a high level of Quality Control systems throughout manufacture, administration, health & safety, and products including that of our suppliers such as profile and hardware. We are required to give BSI unrestricted access to our offices and factories and allow random samples to be selected for testing on a regular basis.

BS7412. PVC-U Windows

A standard for PVC-u windows whereby a series of mechanical and manual tests are carried out to ensure windows against weather performance and durability.

Enhanced Window Security (formerly BS7950)

A standard for PVC-u windows whereby a series of mechanical and manual tests are carried out to ensure windows against an accepted level of burglar resistance.



BS 7412/PAS24
KM 590739



BS EN1279 PT2
KM 37462
AG Glass



Enhanced Door Security

A standard for PVC-u doors whereby a series of mechanical and manual tests are carried out to ensure doors against an accepted level of burglar resistance.

BS EN1279 PT2. Sealed Units

A thorough and daily test routine for double glazed sealed units is carried out to ensure certification. Tests prove that sealed units adhere to correct dew point, sealant correctness and desiccant moisture absorbency.

BFRC. Window Energy Ratings

Windows are assessed using specific glazing and given a rating from A-G for energy efficiency.

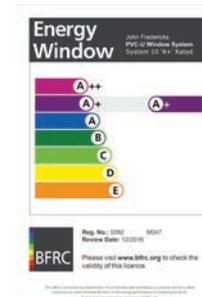





Modern Design ♦ High Security ♦ Energy Efficient
PVC-u Windows & Doors



www.theultimatecollection.uk