

**evolution<sup>®</sup>**



**evolution**<sup>®</sup>

Hand finished excellence comes  
as standard with Evolution



# Contents

- 6 Welcome to Evolution
- 8 About Evolution
- 12 The Collection
  - 14 Storm Windows
  - 20 Flush Windows
  - 26 The English Door
- 36 Design Features
- 46 Glazing Options
- 48 Security
- 52 Colours & Finishes
- 54 Window Hardware
- 58 Door Accessories
- 62 Technical Details
- 68 Gallery



# Welcome to Evolution

## Exquisite, Handcrafted Windows & Doors

Individually designed to adhere to Evolution's exacting principles, our luxury, bespoke windows blend specialist knowledge with the finest materials and craftsmanship to realise the ultimate next generation window. With all the beauty of traditional timber, our windows and doors have to be seen to be believed.

Each window is carefully made with unique and intricate elements. Everything we make is bespoke to your individual needs, wants and requirements, hand finished by our skilled craftsmen. Evolution timber alternative windows and doors are packed full of carefully considered and expertly crafted features that add up to create the perfect luxury enhancement for your home.





# About Evolution

At Evolution, we have always set out to be pioneers in modern window development and are widely considered to be the most innovative and quality driven company in the industry.

We strive to find the best balance between old and new and find that taking the best elements of each yields the most perfect results.

By taking traditional styling and bringing it into the 21st century, we manufacture products that fit today's busy lifestyles, allowing our customers to get the look they desire, as well as the practicality they need.





# Attention to Detail

Hand finished excellence comes as standard at Evolution

We are proud that our team consists of highly skilled and experienced craftspeople who take pride in the products they make each day. It is also true that you will find more people than machinery in our factory.



Our team have learned and honed their trade over many years and all possess an excellent eye for detail. They challenge themselves to create the highest standard of products for our customers.

This expertise and dedication is what sets us apart from other window manufacturers, along with our passion for hand finished excellence.



# The Collection

## Timber Alternative Windows & Doors

Where tradition meets technology, you'll find Evolution at the forefront. Renowned for both innovation and style, Evolution's range of products are in a league of their own. We have an unrivalled history of merging modern design technology with the traditional styling and aesthetic of timber joinery to create a range of products that both look superb and perform at the highest possible level.

We believe that this combination offers our customers the best of all worlds; handcrafted excellence sitting alongside state-of-the-art innovation. We are also proud that our products are designed and manufactured in the UK. With unrivalled aesthetics, exceptional weather proofing and low maintenance, without compromising on quality and design, the perfect window solution for your home is here now.



## Storm

The Storm window is truly unique. Its groundbreaking design means that it carries exquisite styling and authentic features that are usually only found on a traditional timber window. Fusing traditional joinery methods, intricate detailing with modern state-of-the-art technology and performance it delivers a window solution unlike any other.



## Flush

The Flush window is a superb addition to the Evolution collection, perfectly replicating the beauty of traditional flush-fitting timber windows. Featuring authentic timber aesthetics with a clean, fuss-free design the Flush window compliments both period and contemporary homes alike, making this a truly versatile window choice.



## the english door

The English Door offers a stunning collection of timber alternative doors that will enhance any home - from period properties to contemporary new homes. Not only is each and every door made to your exact requirement, every aspect from the design, colour and glazing, down to the detail of door furniture, is chosen by you.



# Storm

*The most unique, advanced  
stormproof window*

Storm is a truly unique window. Its groundbreaking design means that it carries exquisite styling and features that are usually found on a traditional timber window.

Storm also exceeds customer expectation by offering a host of additional benefits, yet none of the drawbacks that come with more traditional windows.

*Right:* Storm white wood effect showcased by a beautiful period property.







**Far Left:** Storm windows with traditional Georgian bar windows and Ventiss window handles.

**Left:** Square leaded Storm cream wood windows with black period curved handles.

**Above:** Storm white wood effect showcased by a contemporary new build property.

### The Evolution Storm timber alternative window range is the pinnacle of stormproof window design and technology.

Our Storm window has taken inspiration from timber, giving it robust, yet beautiful styling as well as intricate detailing to joints and finishing touches.

This window can also be upgraded to include acoustic glass if soundproofing is important to you.

# Storm

Storm also has a host of practical features such as egress/easy clean hinges for easy cleaning, and easy fire escape. It has multi-point shootbolt security locks and security bolts and claws fitted to the hinge side of all locking window sashes. We know that nothing is more important than protecting your family's safety.

The Storm range is a great choice for homes of all styles and ages. So if you are looking for good looks, warmth and security then Storm is the window for you.

- Beautiful timber styling throughout with handcrafted joints
- Exquisite wood effect detailing across all of the frame
- Exceptionally low maintenance
- Slimmer sightlines allow more light into your home
- Over 200 colour options available in addition to our standard wood effect finishes
- Solid looking sill proportions are similar to traditional timber windows (optional extra)
- High quality range of handles and working peg stays available, all designed & manufactured in Great Britain
- Discreet trickle ventilation (optional extra)
- Multipoint locking system
- Centre casement locking with opposing locks
- Lockable night vent facility

Timber-Look Joint providing an authentic finish



True timber proportions and aesthetics



Ventiss teardrop handle



Seam welded window



# Flush

## Traditional aesthetics without traditional pitfalls

The Flush casement window is a superb addition to the Evolution collection, designed to create a stunning focal point and featuring traditional aesthetics. The flush-fitting window is ideal for properties that are replacing original timber windows, or for those wanting authentic looks, but wish to take advantage of modern window technology.

Flush window casements are a timeless, elegant window solution, characterised by openers that close fully into the frame to deliver a beautiful flush appearance.



**Right:** Agate grey Flush windows with traditional Georgian bars.



**Far Left:** Equal sightline timber proportioned window.

**Left:** Agate grey Flush windows with timber-look joints.

### Clean & Sleek Minimalist Design

Why compromise beauty for functionality? Our Flush window systems bring a traditional timber aesthetic to your home, without sacrificing the longevity and energy efficiency of modern designs. The cool, sleek lines of the Flush casement window are a minimalist's dream. Whilst this style of window has been traditionally used in older, cottage style properties, the latest trend is that owners and developers of more contemporary properties are turning to flush style windows as it helps maintain the simplistic, architectural outlook they are striving for.



# Flush

A classic flush-fitting appearance on the exterior, combined with sumptuous textured detail on the interior make this a truly breathtaking window solution. To personalise your Flush windows, you can choose to add Georgian bars, decorative glass or detailed leading to complement your property. With the Evolution Flush window, you can achieve the authentic look of wood, but without the laborious sanding and painting every 5 years. Our innovative woodgrain effect finish ensures a stunning flawless finish and a virtually maintenance free window.

- Beautiful timber styling throughout with handcrafted joints
- Exquisite wood effect detailing across all of the frame
- Exceptionally low maintenance
- Slimmer sightlines allow more light into your home
- Over 200 colour options available in addition to our standard wood effect finishes
- Solid looking sill proportions are similar to traditional timber windows (optional extra)
- High quality range of handles and working peg-stays available, all designed & manufactured in Great Britain
- Discreet trickle ventilation (optional extra)
- Multipoint locking system
- Centre casement locking with opposing locks
- Optional transom drip bar
- Lockable night vent facility

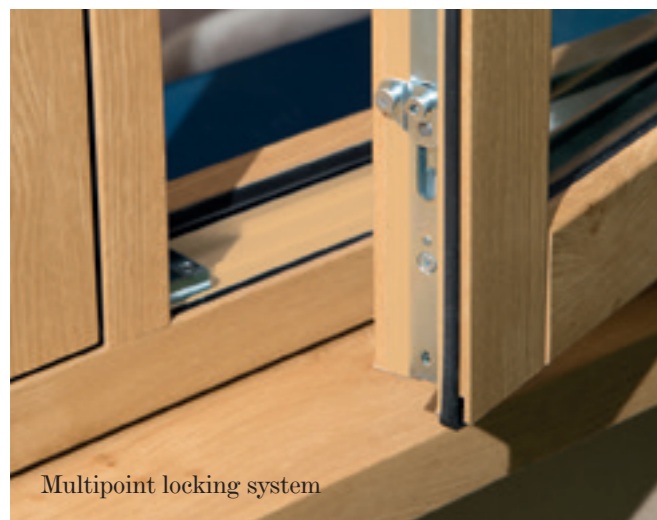

Multipoint locking system



Egress/easy clean hinges



Timber-look joint



Evolution Oak timber proportioned window fitting



# the english door

Inspired door designs to make a grand entrance

The English Door offers the very best in design and manufacturing excellence. By using the latest modern materials, our doors are created to emulate the richness and depth of real timber, but without the problems traditionally associated with wooden doors.

Our long lasting, highly durable doors need very little maintenance. They have excellent thermal and sound proofing properties and extremely efficient security features.

**Right:** Agate grey stormproof entrance door with wrought iron hardware.





**Above:** Solid cast regency 5 inch ring chrome door knocker.

**Right:** Agate grey maple door glazed with solid cast chrome regency hardware.

## Stormproof Entrance Doors

Our range of Stormproof front doors offers you an exciting collection of designs, encompassing authentic representations of period styles for older properties and those with clean, contemporary lines that will complement the character of your home. We even have front doors specifically developed to suit cottage properties that pay homage to the traditional designs. You will find our selection of front door designs will suit any property, regardless of the age or style, you just make it your own by the finishing touches and colours that you choose.



**Left:** Agate grey Linton cottage door with wrought iron hardware.

**Above:** White Standon door with solid cast regency chrome door handle.

## Cottage Doors - Rustic Charm, Timeless Appeal

Our cottage door collection offers all the benefits of a modern door but with the characteristics and period style that delivers a more rustic appeal. This high quality door range is offered with a choice of traditional designs with colour and glazing options to suit any home. A selection of textured, authentic wrought iron accessories complete the look.

At The English Door we do not believe in manufacturing standard size doors. We make every single door to order - to the exact dimensions of your doorway. Each door ordered will be professionally measured and then built to your specification, which will ensure a seamless on site installation experience. At The English Door, hand-finished excellence comes as standard.



**Far Left:** White Hunton design French doors with sidelights and solid cast regency chrome lever/lever handles.

**Left:** White Charlton design French doors with wrought iron handles.

**Above:** Black wrought iron lever/lever handles.

### Traditionally Styled French Double Doors

Our superb handcrafted French doors can truly transform your home, flooding it with an abundance of natural light, as well as providing easy access to your garden or patio. Whether traditionally styled, contemporary or a character property, Evolution tailor make our French doors to perfectly compliment your home. Our French Door collection is available in a wide range of styles and finishes to choose from, to complement the unique style and character of your home.

Our authentically styled timber alternative French Casement doors - or 'double doors' are a charming addition to any home. Each and every

Evolution door is made-to-order, incorporating either full height glazing or solid panels, they create an extensive opening, letting the light flood in and allowing unrestricted access to your outdoor living space or balcony.

As you would expect, the English Door range of French Doors have been meticulously designed to provide outstanding security and unrivalled aesthetics. Each door is equipped with high security multi-point locking systems to ensure total peace of mind, whilst the advanced materials that go into our frames and glazing deliver an equally impressive energy performance - without compromising on style.





# Aluminium Bi-Fold Doors

## Innovative & Visually Stunning

Bi-folding doors glide open to seamlessly join inside and outside space.

Flood any room with natural light and, in just a couple of seconds, open up for extra space and the feel of a cool summer breeze.

The addition of a bi-fold door can completely transform a living space – their flexible nature mean they can be fully opened, partially opened, or totally closed depending on the space available and, naturally, on what the weather's like. Versatile and aesthetically pleasing, our bi-fold doors are the perfect replacement for existing patio or French doors to flood any room with natural light.

All of our bi-fold doors are designed with slim contemporary lines and hidden gearing. Sophisticated hardware has never looked so sleek and stylish.





### The Benefits Of Bi-Fold Doors

It's not just about beauty. The aluminium bi-fold doors utilise industry leading technology that gives you – and your home – the absolute cutting edge in looks, weathering, and security. Our bi-fold doors are the full package – excellence both inside and out.

- Shootbolt locking for all doors and 3 hook locking to master door
- Double and triple glazed options
- Choose from 2 to 6 door panels
- All manufactured hardware achieves Secured By Design

### Aluminium Bi-Fold Door Colour Options

All designed to offer a comprehensive range of contemporary finishes to suit your home and lifestyle. Both single and dual colour options are available.



Black - 9005



Dark Grey - 7016



Slate Grey - 7015



Cream - 9001

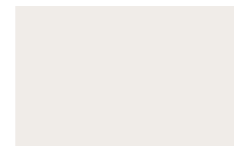

White - 9016



7016 Dark Grey on White



# Design Features

## Where Traditional Joinery Meets Technical Innovation

Traditional on the outside, advanced design on the inside. At Evolution we may offer a traditional aesthetic, but every inch and contour uses the absolute latest in technology for exceptional performance in every one of our window design features.

Innovation, the pursuit for perfection and customer feedback has informed every step of our journey. We talk to our customers about their experiences with us and, more importantly, listen. At every stage of our business, we've made sure that our technology and window design features are at the absolute cutting edge of the industry. Our machines have been built to our own design – only we are able to make windows and doors the Evolution way.

**Right:** Agate grey Flush bay  
Window with timber-look joints.





# Traditional Features

## Beautiful Sightlines

Equal and perfectly balanced sightlines and frame proportions to deliver a greater glazed area, allowing more light into your home.

## Timber Aesthetics

For character and beauty, very little beats the timber aesthetic. Our unique technology marries traditional wooden aesthetics with the highest performing technology. It's not timber. It's something better.

Storm window with equal sightlines.



Internal view of all Storm and Flush windows, illustrating the depth and styling of a traditional timber aesthetic.

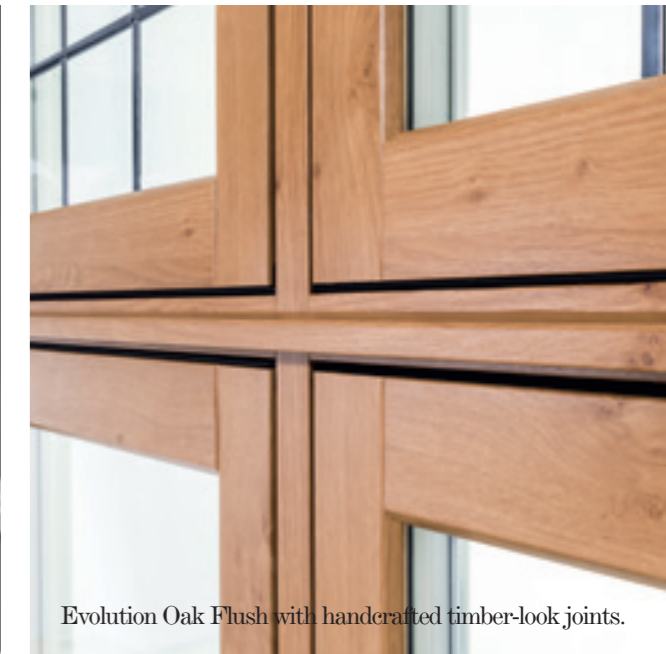

Evolution Oak Flush with handcrafted timber-look joints.

## Handcrafted Joints

Traditionally crafted joints – each one passes through the hands of our team of master craftsmen, giving all the authentic beauty of traditional timber joinery.



Deep timber proportioned sill.

### Traditional Sill Detail

Evolution sills have been developed to authentically replicate the depth of a traditional timber sill, seamlessly blending in with the window design.



Authentic butt hinge.

### Authentic Butt Hinge

Traditional butt hinges help to create a truly authentic timber window aesthetic, reflecting original window design principles. NOTE: This is for cosmetic look only and is not functional.



Seam welded joints.

### Welded Joints

Modern alternative finish to a timber-look joint provides neat 45° seam weld similar to aluminium finish.



Concealed head ventilation.

### Unique Trickle Vent

Our windows can have trickle ventilation. It's easy to miss. Our unique design means you'll be free of unsightly bulges, with a seamless integration that keeps air circulating without compromising aesthetics.



# Timber-Look Joint

Unique, Aesthetic Timber-Look Corner Joint.

Evolution has carved a position for itself as true pioneers in the design and manufacture of traditional, timber alternative windows and doors. Innovation and customer feedback has informed every step of our journey and through this relentless passion for detail we have developed our unique corner joint. Available across the Evolution collection, the aesthetic timber-look joint has been designed to allow all sashes to closely replicate the classic joinery methods used in the production of traditional windows. Timber-look corner joints are the epitome of elegance produce a truly authentic and beautiful window frame. This unique joint has all the beauty of natural timber, but all the strength of a modern weld. All the style of timber without any of the compromise.



**Far Left:** Storm window with timber-look joint.  
**Left:** Flush window with timber-look joint.  
**Above:** Stormproof door with timber-look joint.



## Leaded Windows

### Leaded & Decorative Glazing

Our Storm and Flush casement windows compliment leaded glazing perfectly, with their slim sightlines and equal glass dimensions. Leaded glass has a rich heritage and has been a trusted glass feature of choice over many centuries. Yet it is still as relevant and popular as ever, enhancing both period and contemporary properties.

At Evolution, we can manufacture your windows with elegant and attractive leaded glass, whether it be square leaded, diamond leaded, Queen Anne or a custom design of your choice. We can even incorporate leads with coloured/stained glass, creating a completely unique window for your home. Each and every leaded window we create is completely bespoke, so if your property has existing, decorative windows that you would like to replicate, our Evolution Approved Retailers can help you design them like for like to maintain the original look of your home.

## Georgian Bars

### Traditional Period Features

Evolution are known to be the home of the original timber-alternative Georgian style windows, creating the most authentic-looking Georgian window available on the market today. Our Georgian windows have been modelled to replicate a traditional timber window, with all the proportions of timber, finished with the popular Georgian bar, with ovolo finishing.

The beautiful Georgian bar detailing is guaranteed for 10 years on the finish

and adhesion to the windows and also come with our wood grain finish to ensure they look just like wood. Whether you are looking to match existing styles or design something more bespoke, our Georgian window design team and Evolution approved retailers have complete flexibility to create any configuration you require.

Evolution Georgian bars are available in 2 different sizes. Our 20mm ovolo bar, and our 36mm Cottage style bar.



## Bay Windows

### Styles & Designs

Evolution Storm and Flush windows are available in a range of Bay window designs and styles. The slimness of the sash ensures maximum amounts of light whilst incorporating the attractive period features of traditional joinery.

The equal sightlines of our windows ensure your bay window looks completely symmetrical, a feature that's not always found with modern day windows. There is a wealth of

glass designs available including the popular Georgian bar, and leaded glass designs.

Our bay windows are not just an attractive show piece for your home. They offer full draught exclusion, weather proofing and durability.

## Bow Windows

### Choice & Features

Evolution Storm and Flush windows are available in a range of bow window designs and styles. Similar to bay windows the slimness of the sash ensures maximum amounts of light whilst incorporating the attractive period features of traditional joinery.

The equal sightlines of our windows ensure your bow window looks completely symmetrical, a feature that's not always found with modern day windows. The Evolution bow

windows are flexible in their design and can be designed in 3, 4 and 5 bow segments which will compliment your home.

Our bow windows are not just an attractive show piece for your home. They allow the full range of Evolution design features to be incorporated, including timber-look joints and deep sill.



# Acoustic Glazing

## Noise Control & Sound Insulating Glass

We know from talking to our customers that you are looking for the most energy efficient windows you can buy for your home. Our double glazed windows, our standard offering, are already highly energy efficient, however there are upgradeable options to make your new windows even more efficient, including acoustic glazing.

A key criteria for new windows is minimising sound. There is a comfort in knowing that when you close your windows you are closing out the outside world too. Therefore, we offer an acoustic glass option for both our Storm and Flush window ranges that

can reduce the external noise levels you hear inside your home by up to 30%.

In simple terms, acoustic glazing is a laminated glass which has a noise reduction interlayer not found in standard double glazed units. This layer significantly reduces the amount of excess noise from external sources such as railway lines, roads, air traffic etc. without compromising the U value performance of your windows. If you value a peaceful life from external noise, this is definitely worth considering.

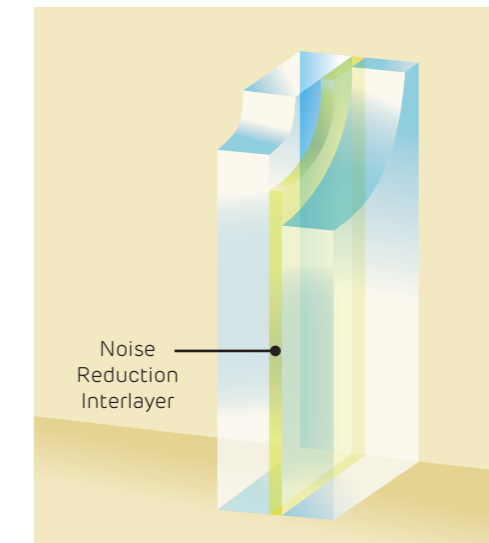





# Superior Security To Protect Your Home

Your security is of paramount importance to us at Evolution, and each and every one of our timber alternative windows and doors are designed to not only look beautiful in your home, but to be highly secure for years to come through the use of solid, sturdy, tested and reliable locking mechanisms and systems.



## Window Security

Evolution uses high security locking on all window product brands - Storm and Flush to keep you and your home safe. Our high security window locks engage on three sides of the opening casement to give maximum protection against intrusion. The other side of the opening sash is made secure by fitting security bolts. So, with all 4 sides of our side or top hung opening sashes secure our customers can be assured that their home is fully protected against would be intruders. Evolution also offers a range of locking handles for extra security on your windows.



**Far Left:** Flush window with double cam night vent facility (Flush with painted rebate).

**Left:** Flush window with reverse action lock system (Flush with painted rebate).

**Above:** Storm window with night vent keep.



## Door Security

All of our timber alternative, English Door doors are supplied with high security multi-point locking built into the door. The locks and cams engage in multiple positions to give maximum protection to your home and belongings. The cylinders used are also high security and boast features such as anti-drill, anti-snap, anti-pick and anti-bump to help keep unwanted intrusion at bay and to keep your home safe and secure for many years.





# Colours & Finishes

## Painted & Traditional Timber Effect Windows & Doors

All of our coloured timber effect windows and doors feature an authentic timber effect foil as standard. Every face of the window and ancillaries will incorporate this traditional wood finish to ensure Evolution windows look as close to timber as possible. Our standard internal colour is white woodgrain. This beautiful combination ensures that the internal face is neutral and will compliment any interior design styles, however should you wish to have both sides of your windows featuring a timber or painted colour finish, this can be created for you.

In addition to our collection of classical timber finishes, Evolution can also paint your windows to one of over 200 RAL colours using our in-house colouring facility. All of our custom painted windows still have the authentic wood grain detail to them to maintain the look and feel of real wood. Our painting process involves applying a hard-wearing coating that has a guarantee of 10 years, but carries the life expectancy of 30+ years for total peace of mind and virtually maintenance free coloured timber effect windows.



Natural Wood



Rosewood

Our standard range of wood grain finishes, plus our popular 'Smooth White' are available in the adjacent colours:



Black



Anthracite Grey



Olive Grey



Agate Grey



Evolution Oak



White Grain



Cream



Smooth White

We can colour match it, creating a window which is truly unique to you and your home.



# Window Hardware

## Traditional & Contemporary Window Handles.

Now that you have considered our window ranges, it is time to think about the finishing touches, so first consider your hardware choices.

Evolution offer three main handle ranges, many also have the option of matching working or decorative peg stays too (range dependant).

- Handles ranges to suit all budgets
- Standard, traditional and contemporary styles
- Decorative or working peg stays available
- Secure locking handles as standard
- Warranties offered on all handles ranges
- Our handles are designed and manufactured in the UK

## Form & Function

Our window handles have not only been designed to work effortlessly with the Storm and Flush window ranges, but also to be ergonomically pleasing to use.

Our carefully chosen ranges include designs and colour finishes to complement all types of properties and interiors.

Every Evolution handle comes with secure locking as standard.



### Standard

As you would expect with Evolution, even our standard window furniture collection boasts exceptional credentials, offering an attractive, contemporary

offset nickel-based window handle which is available in a wide choice of colour and finish options to compliment the Evolution window range.



Standard White



Standard Black



Standard Gold



Standard Chrome



Standard Satin



Standard Bronze

### Traditional

This exclusive, period range of handles and peg stays are an extremely popular choice to accompany Evolution windows. All of the handles are made of solid

wrought iron, and are all completely hand finished in the UK. They are available in 2 different styles, the Monkey Tail and the Period Curved handle.



Period Curved Pewter



Period Curved Black



Bulb-End Pewter



Bulb-End Black



Bulb-End Peg Stay Pewter



Bulb-End Peg Stay Black



Monkey Tail Peg Stay Pewter



Monkey Tail Peg Stay Black



Monkey Tail Pewter



Monkey Tail Black

### Contemporary

The Ventiss range of handles offered by Evolution provide a contemporary yet stylish look to any window. They are available in two window furniture styles, the

elegant Teardrop and the minimalist 360 round Grip handle, the Ventiss range are available with matching peg stays to complete your window transformation.



Ventiss 360 White



Ventiss 360 Black



Ventiss 360 Gold



Ventiss 360 Chrome



Ventiss 360 Satin



Ventiss Teardrop White



Ventiss Teardrop Black



Ventiss Teardrop Gold



Ventiss Teardrop Chrome



Ventiss Teardrop Satin



Ventiss Peg Stay White



Ventiss Peg Stay Black



Ventiss Peg Stay Gold



Ventiss Peg Stay Chrome



Ventiss Peg Stay Satin



# Door Accessories

## The Finishing Touch

We offer a highly desirable range of door hardware that has been carefully selected to complement our door styles and designs.

The extensive ranges comprise traditional, period and contemporary options, all available in various finishes from chrome and brass to gold and wrought iron.

Solid chrome regency doctors knocker.





### Cast Wrought Iron Range

#### Door Handles



Pewter Lever/Lever & Offset Lever/Lever

Black Lever/Lever & Offset Lever/Lever

#### Letter Plates



Pewter Flush Letter Plate Set

Black Flush Letter Plate Set

#### Door Knockers



5 Inch Ring Pewter & Black

Sculptured Pewter & Black

### Solid Cast Regency Range

#### Door Pulls

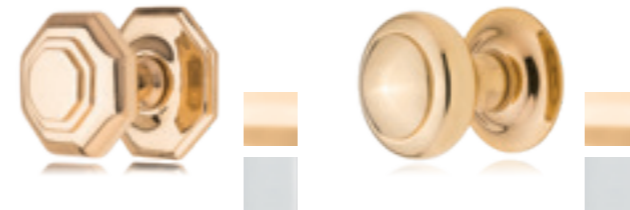

Octagon Brass & Chrome

Round Brass & Chrome

#### Cabin Hooks



Cabin Hooks Brass & Chrome (3, 4, 6, 8, 10, 12, 18 & 24 inc.)

#### Letters & Numbers



Letters & Numbers Brass & Chrome (2 inc.)

#### Door Pulls



Octagon Pewter & Black

Round Pewter & Black

#### Cabin Hooks



Cabin Hooks Pewter & Black (3, 4, 6, 8, 10, 12, 14 & 16 inc.)

#### Letters & Numbers



Letters & Numbers Pewter & Black (2 inc.)

#### Hinge Fronts



Hinge Fronts Pewter & Black

#### Door Studs



Door Studs Pewter & Black

### Solid Cast Regency Range

#### Door Handles



Brass & Chrome Lever/Lever & Offset Lever/Lever

#### Letter Plates



Brass & Chrome Flush Letter Plate Set

#### Door Knockers

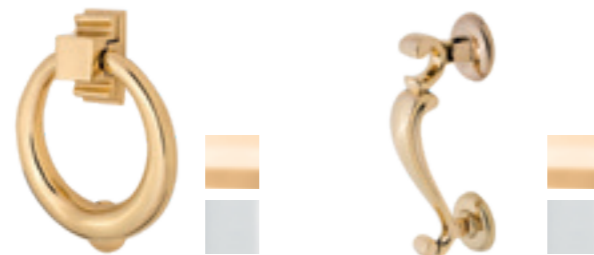

5 Inch Ring Brass & Chrome

Doctors Brass & Chrome

### Standard Range

#### Door Handles



White Lever/Lever

Black Lever/Lever

Gold Lever/Lever

Chrome Lever/Lever

Satin Chrome Lever/Lever

Bronze Lever/Lever



White Lever/Pad

Black Lever/Pad

Gold Lever/Pad

Chrome Lever/Pad

Satin Chrome Lever/Pad

Bronze Lever/Pad

#### Letter Plates



White Letter Plate

Black Letter Plate



Gold Letter Plate

Chrome Letter Plate



Satin Chrome Letter Plate

Bronze Letter Plate

# Technical Details

## Storm1

Frame Work		Page
70mm Frame Depth with Storm Proof Casement Sash		
Glazing Options	Efficiency Rating kWh/m <sup>2</sup> /year	Page
28mm Double Glazing*	✓	
Security		Page
Multipoint Locking System	✓	48
Night Vent Facility	Concealed Trickle Ventilation	Page
✓	✓	41
Glass Options		Page
Low Energy Glass	✓	47
Acoustic Glass	✓	47
Patterned, Coloured & Decorative Lead	✓	44
Handles Options		Page
Standard	✓	56
Ventiss	✓	57
Additional Features		Page
Easy Clean and or Fire Escape Hinges	✓	
Child Restrictors	✓	

NOTE: In large outer frame with Storm Sash the outer frame sightline is 114mm.

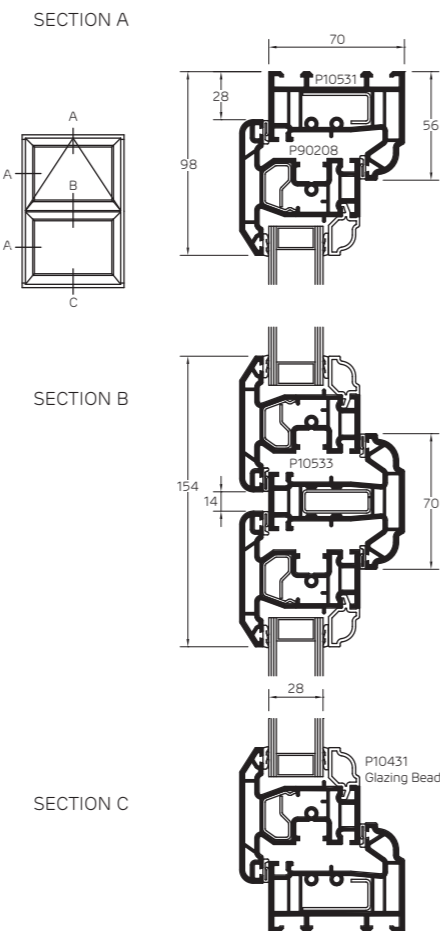

**Storm70**  
56mm Outer Frame Slim

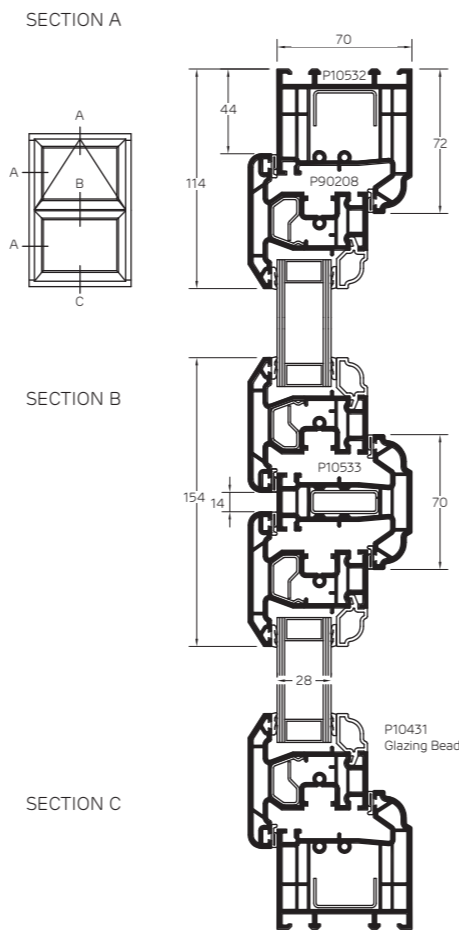

**Storm70**  
72mm Outer Frame Large

## Storm2

Frame Work		Page
82mm Frame Depth with Storm Proof Casement Sash		
Glazing Options	Efficiency Rating kWh/m <sup>2</sup> /year	Page
28mm Double Glazing	✓	
32mm Triple Glazing	✓	
Security		Page
Multipoint Locking System	✓	48
Night Vent Facility	Concealed Trickle Ventilation	Page
✓	✓	41
Glass Options		Page
Low Energy Glass	✓	47
Acoustic Glass	✓	47
Patterned, Coloured & Decorative Lead	✓	44
Georgian Options		Page
20mm Putty / Ovolo	✓ (28mm Double Glazed Only)	44
36mm Putty / Putty	✓ (28mm Double Glazed Only)	44
Handles Options		Page
Standard	✓	56
Wrought Iron	✓	56
Ventiss	✓	57
Additional Features		Page
Easy Clean and or Fire Escape Hinges	✓	
Child Restrictors	✓	

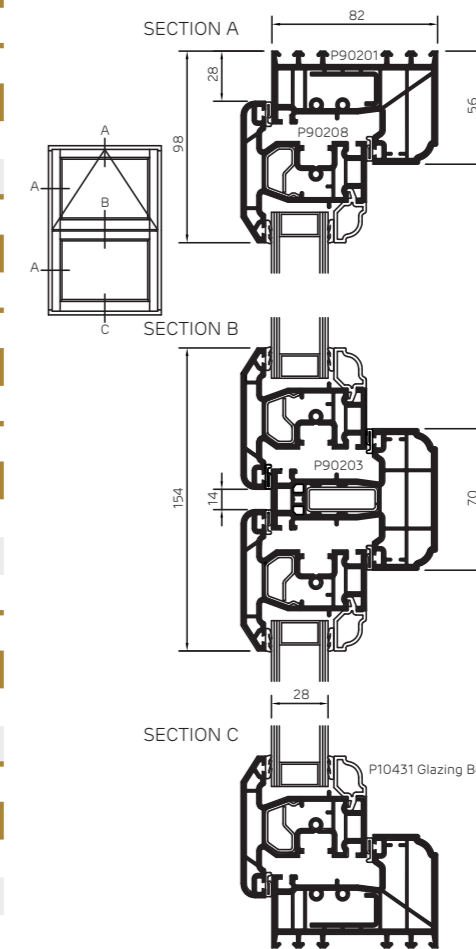

**Storm82**  
56mm Outer Frame Slim

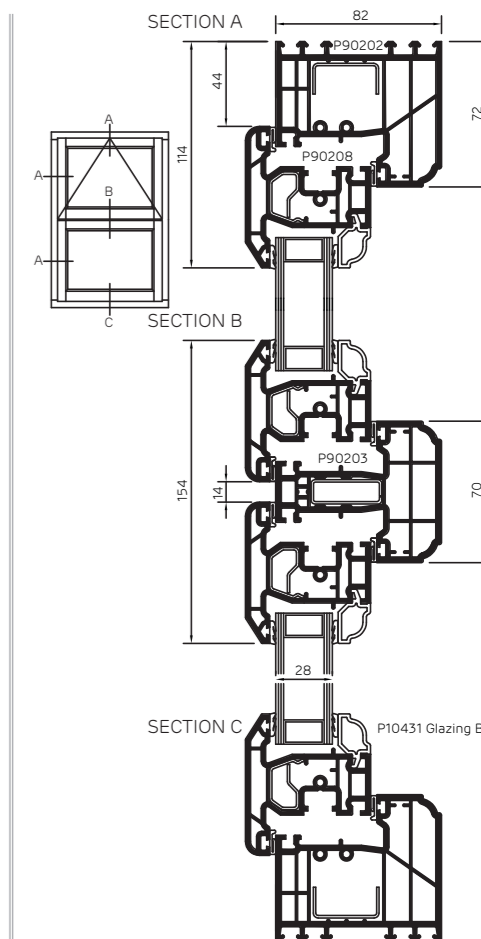

**Storm82**  
72mm Outer Frame Large





## Flush70

Frame Work		Page
70mm Frame Depth with Flush Casement Sash		
Glazing Options		Page
28mm Double Glazing*	✓	
Security		Page
Multipoint Locking System	✓	48
Night Vent Facility		Page
✓	Concealed Trickle Ventilation	41
Glass Options		Page
Low Energy Glass	✓	47
Acoustic Glass	✓	47
Patterned, Coloured & Decorative Lead	✓	44
Handles Options		Page
Standard	✓	56
Ventiss	✓	57
Additional Features		Page
Easy Clean and or Fire Escape Hinges	✓	
Child Restrictors	✓	

NOTE: In large outer frame with Flush Sash the outer frame sightline is 118mm.

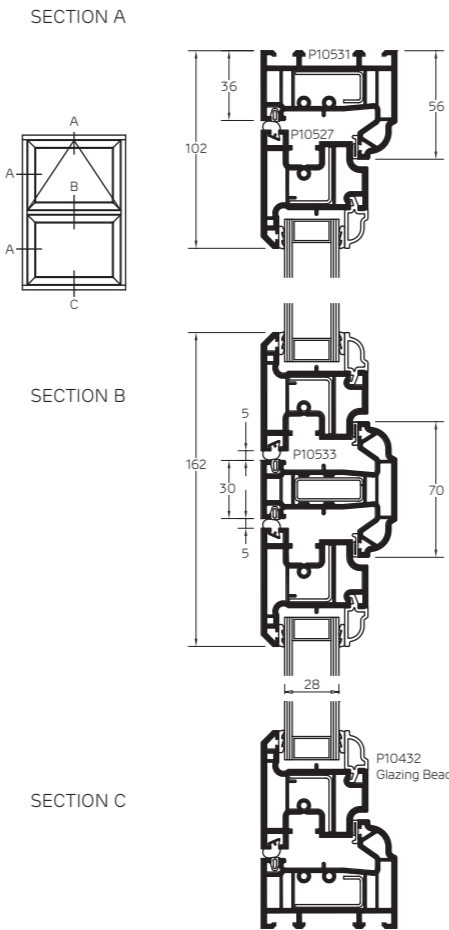

**Flush70**  
56mm Outer Frame Slim

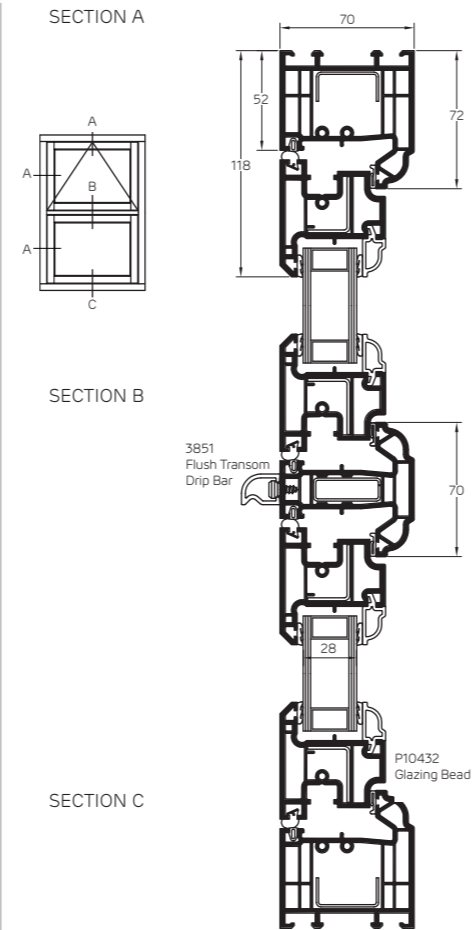

**Flush70**  
72mm Outer Frame Large

## Flush82

Frame Work		Page
82mm Frame Depth with Flush Casement Sash		
Glazing Options		Page
28mm Double Glazing	✓	
32mm Triple Glazing	✓	
Security		Page
Multipoint Locking System	✓	48
Night Vent Facility		Page
✓	Concealed Trickle Ventilation	41
Glass Options		Page
Low Energy Glass	✓	47
Acoustic Glass	✓	47
Patterned, Coloured & Decorative Lead	✓	44
Georgian Options		Page
20mm Putty / Ovolo	✓ (28mm Double Glazed Only)	44
36mm Putty / Putty	✓ (28mm Double Glazed Only)	44
Handles Options		Page
Standard	✓	56
Wrought Iron	✓	56
Ventiss	✓	57
Additional Features		Page
Easy Clean and or Fire Escape Hinges	✓	
Child Restrictors	✓	

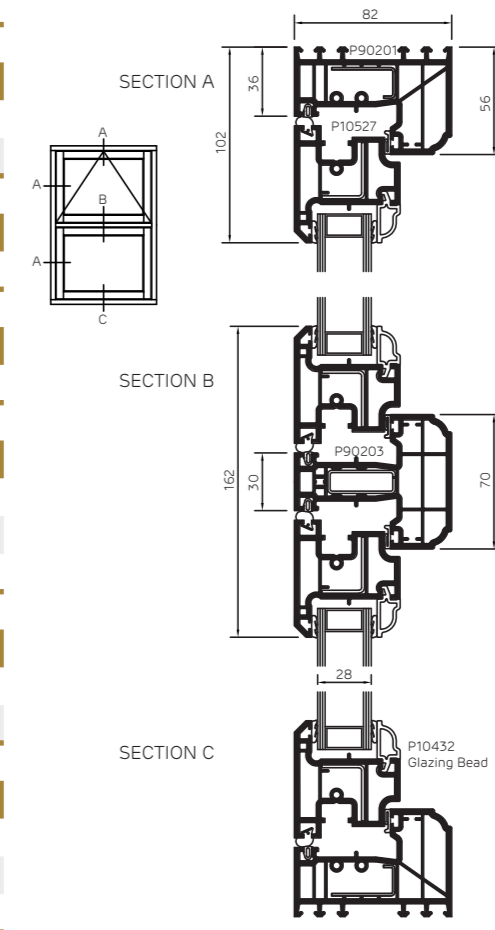

**Flush82**  
56mm Outer Frame Slim

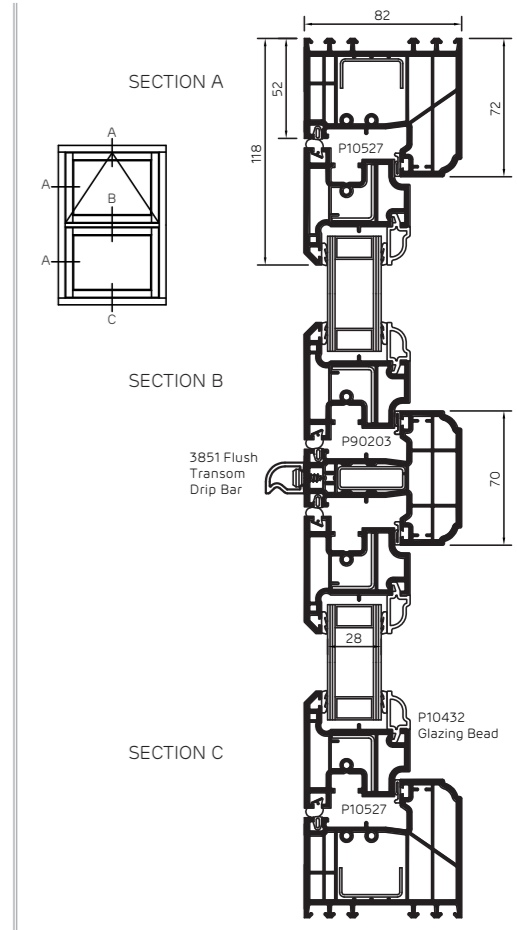

**Flush82**  
72mm Outer Frame Large



## The English Door

<b>Frame Work</b>		<b>Page</b>
82mm Frame Depth		
<b>Glazing Options</b>		<b>Page</b>
28mm Double Glazing	✓	
32mm Triple Glazing	✓	
<b>Security</b>		<b>Page</b>
Multipoint Locking	✓	50
<b>Glass Options</b>		<b>Page</b>
Low Energy Glass	✓	47
Acoustic Glass	✓	47
Patterned, Coloured & Decorative Lead	✓	44
<b>Handles Options</b>		<b>Page</b>
Standard	✓	61
Wrought Iron	✓	60
Regency Range	✓	60
<b>Additional Features</b>		<b>Page</b>
Unlimited Range of Colours	✓	53

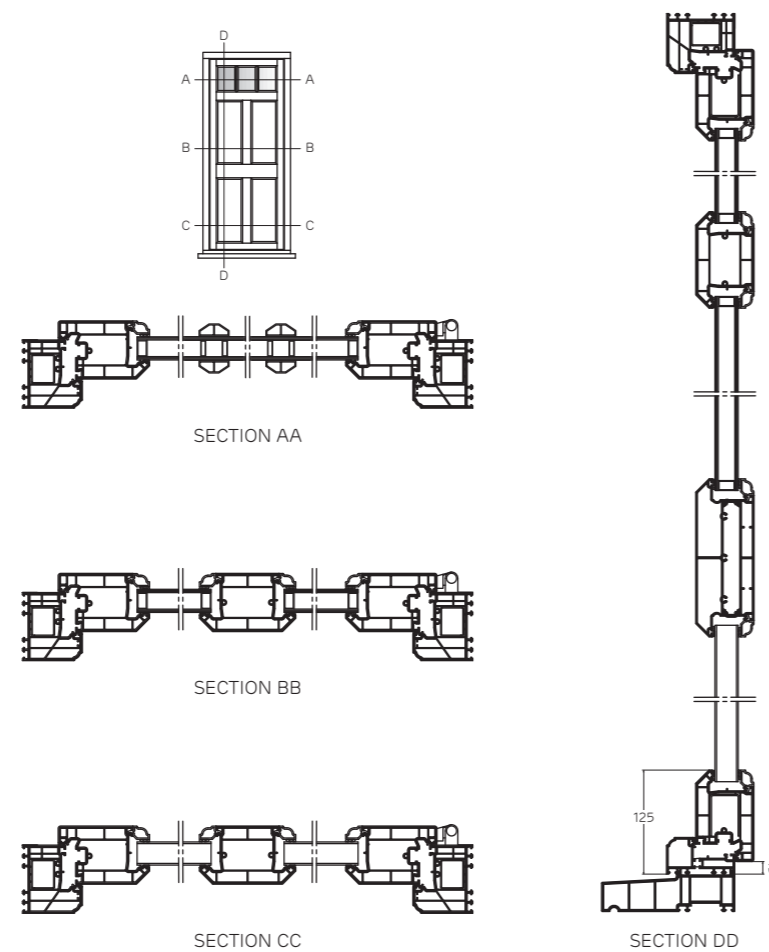

The English Door  
Ballington Door







Bespoke sprayed Boxmoor door with regency chrome letter plate.

**evolution**<sup>®</sup>